

Forceps

Botvin

Iris Forceps
For peripheral iridectomies.

K5-1040 serrated tips

K5-1050 1x2 teeth



Gills-Colibri

Tissue Forceps
very fine pointed tips
with tying platform

K5-1450



Colibri Style

Tissue Forceps
very delicate, 1x2 teeth, 0.12mm

K5-1500 Colibri

K5-1520 Harms-Colibri, with tying platform

KT5-1520 Harms-Colibri, titanium, with tying platform

K5-1522 Dyson-Colibri, short tips, extremely thin shanks, with tying platform



Standard, 1x2 teeth with tying platform

K5-1550 Colibri, 0.4mm

Corneal Suturing Forceps

very delicate, 1mm spread, 1x2 teeth, 0.12mm

K5-1560 Polack

Corneal Forceps

very delicate, 1x1 teeth, 0.1mm

K5-1700 Pierse-Colibri



K5-1500



K5-1520



K5-1522



K5-1550



K5-1560



K5-1700

Forceps

Hofmann-Polack

Corneal Suturing Forceps
with guide pin
1mm spread
1x1 teeth, 0.2mm

K5-1566



Hoskin

Tissue Forceps, curved
K5-1716 #16, fine grooved tips



Hoskin

Tissue Forceps, straight
K5-1718 #18, fine grooved tips
K5-1719 #19, micro grooved tips
K5-1728 #28, very delicate, micro grooved tips



K5-1718

K5-1719

K5-1728



Forceps

Hoskin

Tissue Forceps, Colibri style

K5-1722 #22, micro grooved tips

K5-1730 #30, very delicate micro grooved tips

K5-1734 #34, pointed tips



K5-1722



K5-1730



K5-1734



Pierse

Corneal Forceps

very delicate
1x1 teeth, 0.1mm
straight

K5-1800



Fechtner

Conjunctiva Forceps

very delicate
ring shaped tips
with tying platform

K5-1820

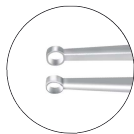

Castroviejo-Colibri

Forceps

very delicate
1x2 teeth, 0.12mm

K5-1900

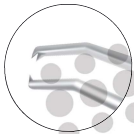

Forceps

Harms-Colibri

Forceps
very delicate
1x2 teeth, 0.12mm
with tying platform
K5-1902



Hyde

Corneal Forceps
2x2 teeth, 0.12mm
with tying platform
K5-1920



Bonn

Forceps
very delicate
1x2 teeth, 0.12mm
K5-2000



Bonn

Forceps
1x2 teeth, 0.12mm
with tying platform
K5-2020 stainless steel
KT5-2020 titanium



Forceps

Thorpe

Corneal Forceps
 2x3 teeth, 0.12mm
 with tying platform
K5-2100



McPherson

Tissue Forceps
 1x2 teeth, 0.4mm
 with tying platform
K5-2300 straight
K5-2310 angled



Kelman-McPherson

Forceps
 8mm long jaws
 1x2 teeth, 0.3mm
K5-2330



Hoffer-McPherson

Forceps
 very delicate
 11mm long jaws
 1x2 teeth, 0.12mm
K5-2350

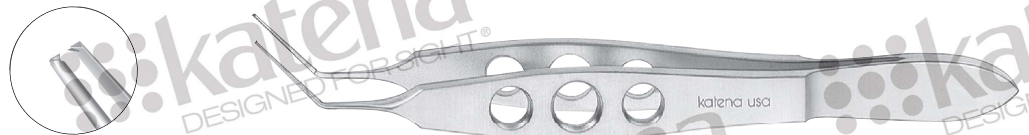

Forceps

Castroviejo

Suturing Forceps
1x2 teeth
with tying platform

K5-2500 0,12mm

K5-2510 0,3mm

K5-2520 0,5mm

K5-2530 0,9mm

KT5-2500 0,12mm, titanium



Snider-Castroviejo

Suturing Forceps
with guide pin
1x2 teeth, 0,12mm
with tying platform

K5-2550



Stern-Castroviejo

Fixation Forceps
1x2 teeth, 0,5mm
with lock

K5-2552



Moody

Fixation Forceps
1x2 teeth, 0,5mm
with lock

K5-2553 left (not shown)

K5-2554 right

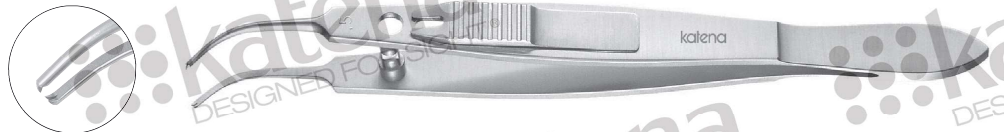

Forceps

Helveston

Fixation Forceps
1x2 teeth, 0.6mm
For globe fixation
during strabismus
procedures.

K5-2556



Girard

Corneoscleral Forceps
1x2 teeth, 0.12mm
with tying platform

K5-2900 for use in right hand

K5-2910 for use in left hand



Perl

Corneal Forceps
1x2, 0.08mm teeth
For atraumatic grasping
and fixation of tissue.

K5-2912 for use in right hand

K5-2914 for use in left hand



Maumenee-Colibri

Corneal Forceps
very delicate
1x2 teeth, 0.12mm

K5-3000



Forceps

Bishop-Harmon

Tissue Forceps

1x2 teeth

K5-3500 delicate

K5-3510 standard (not shown)



Bishop-Harmon

Dressing Forceps

criss-cross serrated tips

K5-3550



Fixation Forceps

1x2 teeth, 0.3mm

K5-3560 Sauer

K5-3562 Manhattan Eye & Ear,
with tying platform

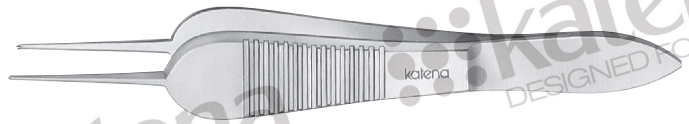

Dressing Forceps

serrated, delicate

K5-4000 straight

K5-4010 curved



Forceps

Tissue Forceps

1x2 teeth

K5-4100 delicate, straight

K5-4110 delicate, curved (not shown)

K5-4140 standard, straight (not shown)



Adson

straight, 5" (125mm) long

K5-4150 Dressing Forceps
serrated jaws,
delicate

K5-4152 Dressing Forceps
serrated jaws,
standard

K5-4170 Tissue Forceps
1x2 teeth, delicate

K5-4172 Tissue Forceps,
1x2 teeth, standard

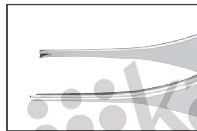

1x2 teeth, delicate

Bayonet

Dressing Forceps

serrated jaws

5 3/4" (146mm) long

K5-4180



Lester

Fixation Forceps

straight

K5-4300 1x2 teeth

K5-4320 2x3 teeth (not shown)



Forceps

Fixation Forceps

1x2 teeth

K5-4500 Bracken, delicate teeth

K5-4550 Elschnig, standard teeth
(not shown)



Troutman

Superior Rectus
Forceps

1x2 teeth
angled

K5-4700



Tying Forceps

For 8-0 to 11-0 sutures.

McPherson

5mm long smooth jaws

K5-5000 straight

KT5-5000 straight, titanium

K5-5010 angled

KT5-5010 angled, titanium

Kelman-McPherson

7.5mm long smooth jaws

K5-5030 angled

KT5-5030 angled, titanium

Bechert

10mm long smooth jaws

K5-5049 angled

Gaskin

11mm long smooth jaws

K5-5050 angled



K5-5000

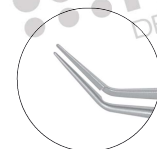

K5-5010



K5-5030



K5-5049



K5-5050

Forceps

Haberle-McPherson

Lens Holding Forceps
 7.5mm long jaws
 with groove, angled
 For grasping IOL haptic.

K5-5040



Kurstin

Flap Stretching Forceps
 disc shaped
 serrated jaws
 Designed for stretching
 the flap to eliminate striae.

K5-5056

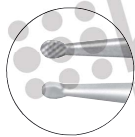

Buratto

LASIK Flap Forceps
 disc shaped
 serrated jaws

K5-5058



Mendez

Multi-Purpose
 LASIK Forceps
 spatulated jaws and tips
 smooth grasping surfaces
 vaulted shanks
 For lifting, dissecting and
 grasping the corneal flap.

K5-5060



Forceps

Inamura

Capsulorrhexis Forceps
delicate tapered shanks
to seal the incision during
continuous curvilinear
capsulorrhexis
Excellent for MICS.

K5-5070



Utrata

Capsulorrhexis Forceps
very delicate, short handle
triangular grasping tips
extremely thin with landmarks
at 2,5mm and 5,0mm

K5-5071 - straight



Masket

Capsulorrhexis Forceps
very delicate, short handle
triangular grasping tips
extremely thin with landmarks
at 2,5mm and 5,0mm

K5-5074 vaulted



Kraff

Capsule Tag Forceps
11mm long shanks
1.5mm long grasping tips

K5-5080



Forceps

Utrata

Capsulorrhexis Forceps
very delicate
triangular grasping tips
extremely thin
11mm long shanks

K5-5081 stainless steel

KT5-5081 titanium

Also available for MICS, see K5-5091.



Utrata

Capsulorrhexis Forceps
very delicate
triangular grasping tips
extremely thin
11mm long shanks
round handle with guide pin
for alignment

K5-5082



Nevyas

Capsulorrhexis Forceps
cystotome shaped tips
extremely thin
11mm long shanks
For tearing and grasping
the anterior capsule.

K5-5083

Also available for MICS, see K5-5093.



Masket

Capsulorrhexis Forceps
very delicate
triangular grasping tips
extremely thin 11mm long
vaulted shanks

K5-5084



Forceps

Masket

Capsulorrhexis Forceps
 very delicate
 triangular grasping tips
 extremely thin 11mm long
 vaulted shanks
 round handle with guide pin
 for alignment

K5-5086



Jaffe

Capsulorrhexis Forceps
 very delicate
 round grasping tips
 extremely thin
 11mm long shanks

K5-5088



Giannetti

MICS Capsulorrhexis Forceps
 ultra delicate shanks and tips
 maximum jaw opening 1.75mm
 For performing capsulorrhexis
 through a micro incision.

K5-5090



Utrata

MICS Capsulorrhexis Forceps
 very delicate
 triangular grasping tips
 thin 11mm shanks
 maximum jaw opening 1.75mm
 For performing capsulorrhexis
 through a micro incision.

K5-5091



Forceps

Giannetti

MICS Capsulorrhexis Forceps
 ultra-delicate shanks and tips
 maximum jaw opening of 1.75mm
 flat handle
 For performing capsulorrhexis
 through a micro incision.

K5-5092



Neyvas

MICS Capsulorrhexis Forceps
 cystotome shaped tips
 ultra-delicate shanks and tips
 maximum jaw opening of 1.75mm
 flat handle
 For penetrating and grasping the anterior
 capsule while performing a capsulorrhexis
 through a micro incision.

K5-5093



Florakis

Endothelial Forceps
 extra-delicate, reversed
 triangular tips angled 75°
 To aid in the removal of endothelium
 from the host cornea.

K5-5095



Sinskey

Tying Forceps
 very delicate
 smooth jaws
 For 8-0 to 11-0 sutures.

K5-5100 straight

K5-5110 curved (not shown)



Forceps

Anis

Tying Forceps
extra delicate
smooth jaws
For 9-0 to 11-0 sutures.

K5-5112 straight (not shown)

K5-5113 curved



Freeman-Jaffe

Lens Holding Forceps
with longitudinal groove
For grasping IOL haptic.

K5-5190



Jaffe

Tying Forceps
very delicate
smooth jaws
6mm long platform
For 8-0 to 11-0 sutures.

K5-5200 straight

K5-5210 curved



Gerl

Tying Forceps
curved shanks
6mm long platform
For 8-0 to 11-0 sutures.
titanium

KT5-5215



Forceps

Tennant

Tying Forceps
extra delicate smooth jaws
with 6mm long platform
round handle with guide pin
For 9-0 to 11-0 sutures.

- K5-5220** straight
- KT5-5220** straight, titanium
- K5-5230** curved
- KT5-5230** curved, titanium



Maumenee

Tying Forceps
concave-convex jaws
round handle with guide pin
For 8-0 to 11-0 sutures.

- K5-5234** straight
- K5-5235** angled



JAWS CROSS SECTION



Harms

Tying Forceps
standard, smooth jaws
for 7-0 to 9-0 sutures.

- K5-5400** straight
- K5-5410** curved

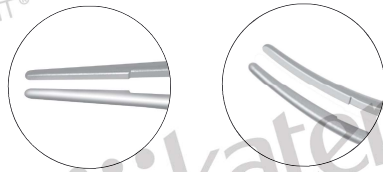

Helveston

Tying Forceps
standard, smooth jaws
For 4-0 to 6-0 sutures.

- K5-5420**

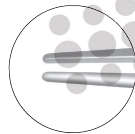

Forceps

Fine

Tying Forceps
standard, smooth jaws
For 7-0 to 9-0 sutures.

K5-5550



Arita

Meibomian Gland Compressor
broad, smoothly polished jaws

K5-5900

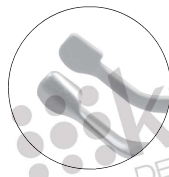

Barraquer

Cilia Forceps
lightly angled
Textured jaws provide
superior grasping capabilities.

K5-6000

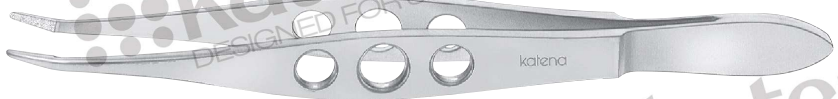

Katena

Cilia Forceps
slanted jaws
gold plated

K5-6020



Gradle

Cilia Forceps
smooth jaws

K5-6100



Forceps

Bonaccolto

Conjunctiva Forceps
longitudinally serrated jaws
with cross serrations at tips

K5-6200 1.2mm wide

K5-6210 1.7mm wide (not shown)

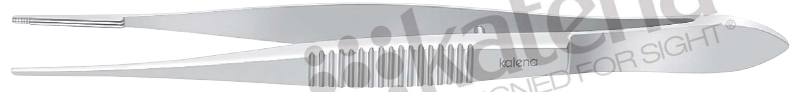

Nugent

Utility Forceps

K5-6214 smooth jaws (not shown)

K5-6215 serrated jaws



Gold

Punctal Plug Forceps
0.2mm wide longitudinal
groove inside jaws
pointed tips

K5-6218



Foreign

Body Forceps
straight

K5-6400



Forceps

Utility & Splinter

Forceps
pointed, short jaws
Suitable for epilation.
K5-6500 #H



Jewelers

Forceps
standard, straight
K5-6510 #1



Jewelers

Forceps
delicate, straight
K5-6520 #3-C



Jewelers

Forceps
delicate, straight
K5-6530 #3



Jewelers

Forceps
delicate, straight
K5-6540 #4



Forceps

Jewelers

Forceps
extra delicate, straight
K5-6550 #5



Jewelers

Forceps
extra delicate, angled
K5-6560 #5/45



Jewelers

Forceps
curved
K5-6570 #7



Suture

Removal Forceps
very fine pointed tips
with textured jaws
Ideal for grasping wet sutures.
K5-6575



Forceps

Jaffe

Utility Forceps
very delicate smooth jaws
curved

K5-6600



Arruga

Capsule Forceps

K5-7000



Akahoshi

Phaco PreChopper

4.5mm long delicate jaws
with sharp tips

For cracking, dividing and rotating
the nucleus without sculpting.

K5-7230



Akahoshi

Combo PreChopper

For cracking, dividing and rotating
both hard and soft nuclei without
sculpting.

K5-7232



Forceps

Ernest

Nucleus Cracker
 extra delicate cross-action
 serrated paddle tips

K5-7240 For cracking the nucleus through a 2.5mm incision.

K5-7242 For cracking the nucleus through a 2mm incision.



Dodick

Nucleus Cracker
 cross-action
 longitudinally serrated
 paddle shaped jaws
 For cracking the nucleus through a 3mm incision.

K5-7244



Hu

Femto Forceps
 blunted 0.3mm tips
 cross-action mechanism
 For opening incisions created with a femtosecond laser.

K5-7245

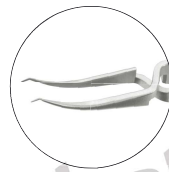

Alfonso

Nucleus Grasping Forceps
 two short rows of delicate interlocking teeth
 For grasping and extracting nucleus fragments.

K5-7253



Forceps

Femto

Nucleus Forceps
 22 gauge
 flattened textured tips
 angled at 90°
 reverse action

For removing a complete cap,
 finishing a rhexis and
 splitting nucleus fragments.

K5-7270



Vitreo-Retinal Forceps

stainless steel with
 serrated plastic handle
 autoclavable



smooth jaws
 20 gauge, straight
K5-7500

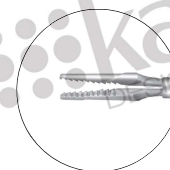

serrated jaws
 20 gauge, straight
K5-7510



smooth jaws, 1x2 teeth
 20 gauge, straight
K5-7520



smooth jaws
 end gripping
 20 gauge, straight
K5-7530



smooth jaws
 20 gauge, vertical
K5-7540

Forceps

Endothelial Grasping Forceps

curved, 23 gauge
delicate end-gripping platforms
jaws 90° off-set from
“squeeze handle”
mechanism

K5-7550



ICL™

Lens Cartridge Loading Forceps
straight, 20 gauge
jaws feature a series
of concave and
convex surfaces

K5-7560

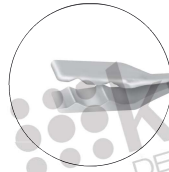

Donnenfeld

Micro IOL Holding Forceps
21 gauge
blunt, paddle-shaped tips
central hole for traction and visibility
*For grasping a soft IOL during cutting
and explantation.*

K5-7570

(use with K4-5560)



Forceps

MICS Capsulorrhexis Forceps

23 gauge curved shaft with short micro-grasping tips
Designed for use through a very small paracentesis.

K5-7651 Alio

K5-7655 Fine-Ikeda



K5-7651



K5-7655



Katena

“Squeeze Handle” Forceps
These “squeeze handle” instruments feature titanium handles to reduce overall weight, and front ends of hardened stainless steel for secure grasping.



horizontal opening serrated jaws

K5-7600 20ga.

K5-7703 23ga.



horizontal opening end gripping jaws

K5-7610 20ga.

K5-7713 23ga.

K5-7715 25ga.

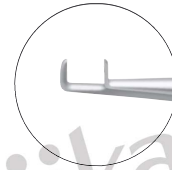

vertical opening smooth side gripping jaws

K5-7620 20ga.



membrane peeling smooth 45° angled jaws

K5-7630 20ga.



membrane peeling grooved 45° angled jaws

K5-7631 20ga.



asymmetrical

K5-7723 23ga.

K5-7725 25ga.



ILM

K5-7733 23ga.

K5-7735 25ga.

Forceps

Prasad

Micro Tying Forceps
 23 gauge
 straight 2,65mm long jaws
 with textured platforms
 25mm long curved shaft

- K5-7743** straight
- K5-7753** angled

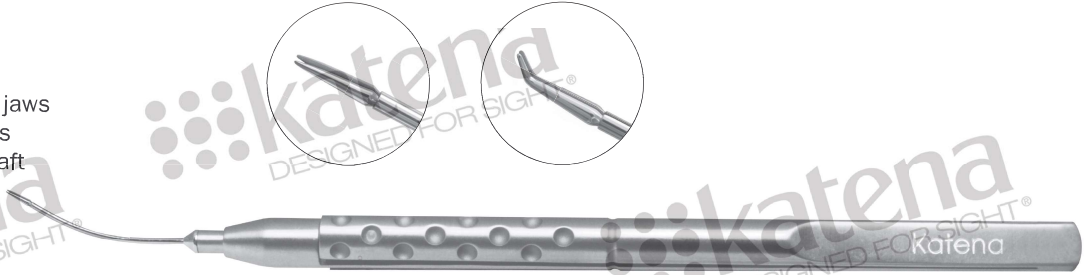

Watzke

Sleeve Spreading Forceps

K5-7950



Feaster

Lens Holding Forceps
 gently curved shank
 0,25mm diameter round tip
 with guard

K5-8001

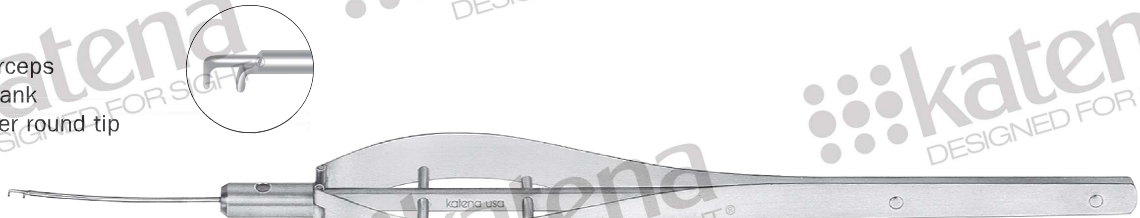

Rosenwasser

Donor Lamella Inserting Forceps
 thin vaulted 12mm long shanks
 precalibrated heel stop to
 prevent tips from closing

K5-8010



Forceps

ICL™

Loading Forceps
11mm long
smoothly polished jaws

K5-8180



ICL™

Loading Forceps
11mm long
finely textured jaws

K5-8181



Dodick

IOL Folding Forceps
For soft IOLs.

K5-8210

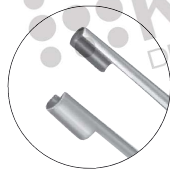

Forceps

Livernois

IOL Folding Forceps
 concave jaw surfaces
 For soft IOLs.

K5-8215

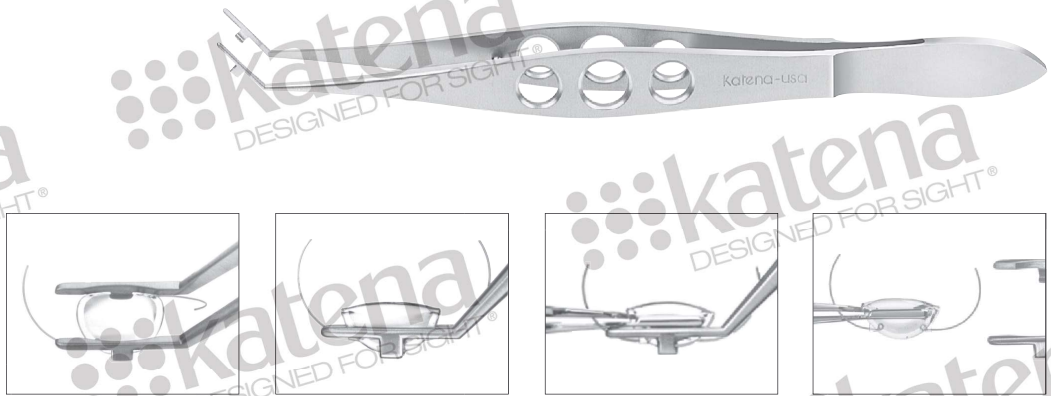

Steinert

IOL Inserting Forceps
 conically shaped jaws
 with flat inside surfaces
 Used for folding and
 inserting soft IOLs.

K5-8219



Livernois

IOL Holding Forceps
 highly polished round jaws
 For holding a soft IOL
 while folding with an
 inserting forceps.

K5-8220 straight (not shown)

K5-8221 angled



Forceps

Livernois-McDonald

IOL Inserting Forceps
5mm long concave jaws
patented cross-action
For inserting silicone IOLs.
K5-8225



Ernest-McDonald

IOL Inserting Forceps
5mm long straight jaws
low profile
patented cross-action
For inserting silicone IOLs.
K5-8228



Ernest-McDonald II

IOL Inserting Forceps
5mm long straight jaws
extra low profile
patented cross-action
For inserting silicone IOLs.
K5-8229



Faulkner

Lens Holding Forceps
round, smooth jaws
For holding soft IOLs.
K5-8230

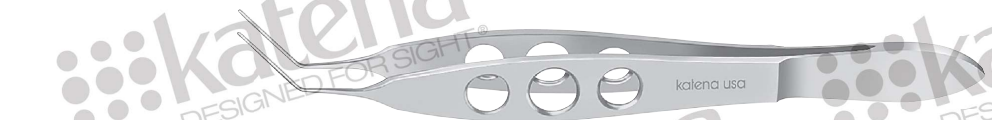

Forceps

Buratto

Soft IOL Inserting Forceps
 extra delicate highly
 polished convex jaws
 For foldable acrylic and
 silicone IOLs.

K5-8268

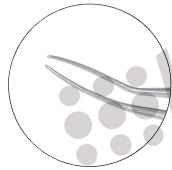

Spaleck

Soft IOL Inserting Forceps
 delicate highly polished
 convex jaws
 For foldable acrylic and
 silicone IOLs.

K5-8270



Ernest-McDonald

IOL Inserting Forceps
 polished bi-convex jaws
 patented cross-action
 For acrylic IOLs.

K5-8272



JAWS CROSS SECTION



Bechert

Lens Holding Forceps
 very delicate flat jaws
 gently curved

K5-8476



Forceps

Kratz

Lens Holding Forceps
very delicate narrow jaws
curved

K5-8480



Blaydes

Lens Holding Forceps
very delicate narrow jaws
angled 45°

K5-8500



KAMRA™

Inlay Forceps
very thin, highly polished
paddle-shaped jaws
*For use in picking up and placing
the Kamra™ implant.*

K5-8510



Shepard

Lens Holding Forceps
duckbill shaped jaws
gently curved

K5-8600



Forceps

Clayman

Lens Holding Forceps
delicate angled jaws
gently curved

K5-8700



Jameson

Muscle Forceps
with slide lock

K5-9000 4 teeth, child size, right

K5-9010 4 teeth, child size, left (not shown)

K5-9020 6 teeth, adult size, right (not shown)

K5-9030 6 teeth, adult size, left



Berke

Ptosis Forceps
with slide lock
longitudinally grooved jaws

K5-9300 20mm long

K5-9310 27mm long



Forceps

Ptosis

Lid Clamp
6-pin, concave
longitudinal grooves
in tips, sliding lock

K5-9315

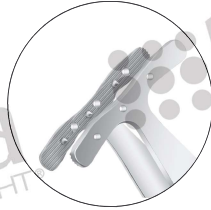

Erhardt

Lid Forceps

K5-9400



Downes

Lid Clamp
Designed for protecting the
eye and holding the lid margin
during upper lid laser
blepharoplasty.

K5-9410



Forceps

Chalazion Forceps

round

K5-9450 Lambert, 8mm I.D.

K5-9500 Hunt, 12mm I.D.



Chalazion Forceps

oval

K5-9550 Baird, 11 x 8mm I.D.
small

K5-9600 Francis, 14 x 11mm I.D.
medium

K5-9650 Desmarres, 20 x 13mm I.D.
large

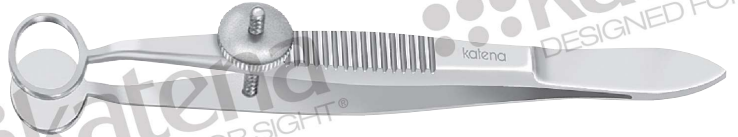

K5-9600

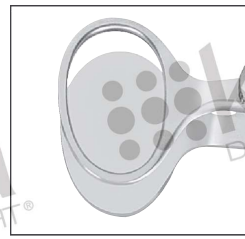

K5-9650

Wies

Chalazion Forceps
grooved upper jaw

K5-9750



Forceps

Serrefine

serrated jaws
small
1½" (38mm) long
K5-9850



Hartmann

Mosquito Forceps
extra delicate
3¾" (95mm) long
K5-9900 straight
K5-9910 curved



Halsted

Mosquito Forceps
delicate
5¾" (145mm) long
K5-9940 straight
K5-9950 curved



Forceps

Baby Jones

Towel Clamp
cross-action
2¼" (55mm) long
K5-9960



Backhaus

Towel Clamp
K5-9964 3½" (90mm) long
K5-9965 5¼" (135mm) long

